

1 Concord Nilo 800

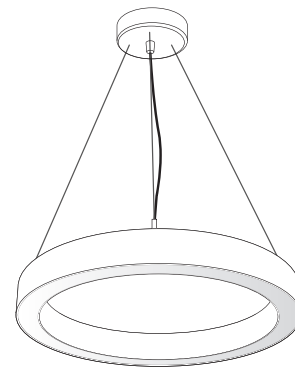

1 ⚡ 220-240V~+ ⚠

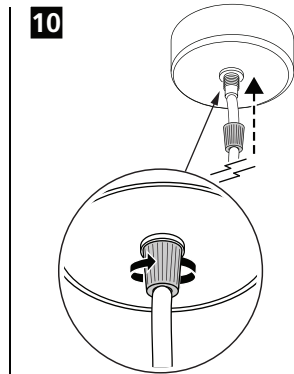
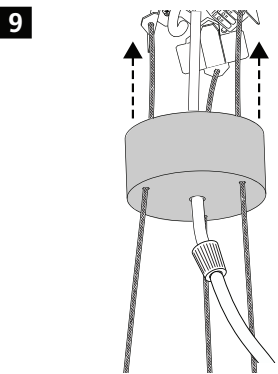
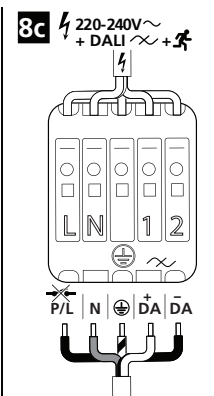
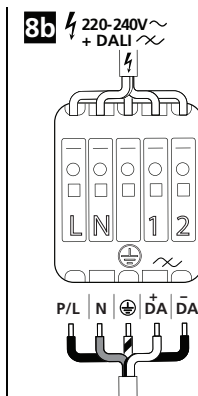
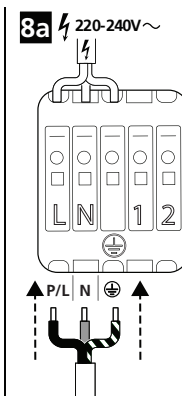
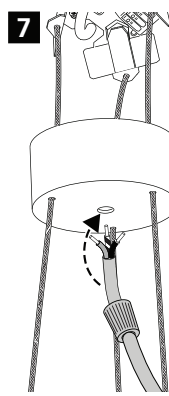
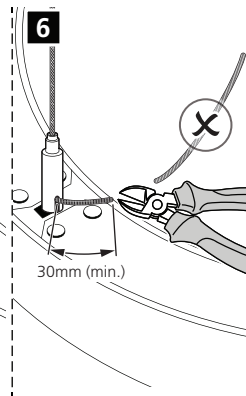
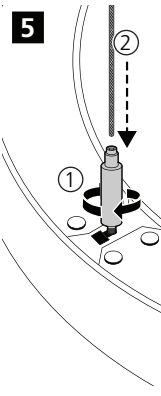
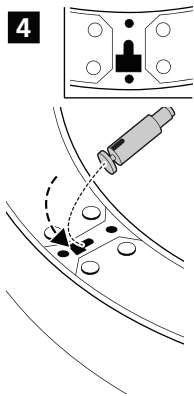
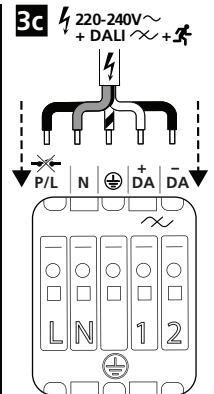
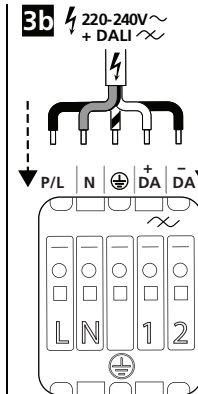
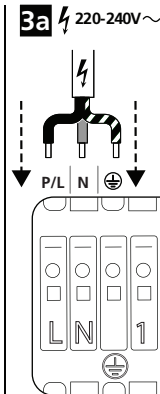
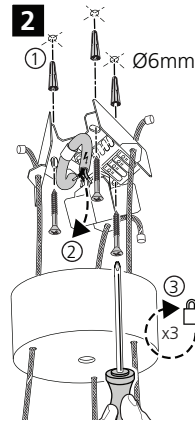
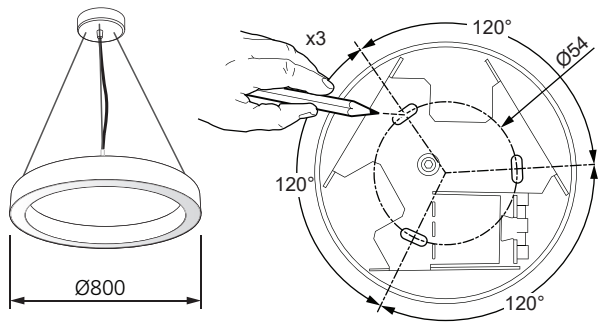
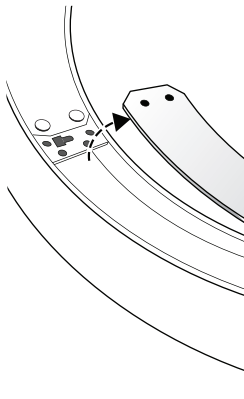
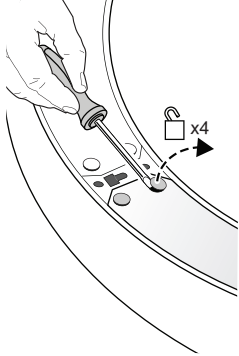

2 ⚡ 220-240V~+ ⚠

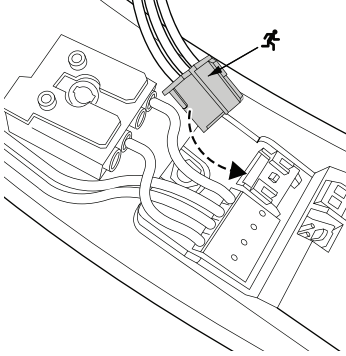

3

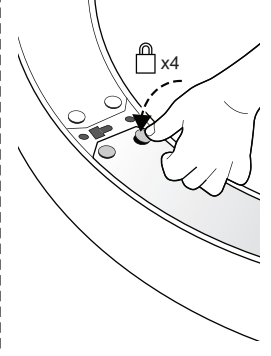
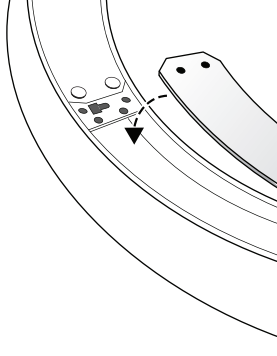

1 ⚠

⚡ 220-240V~+ ⚠

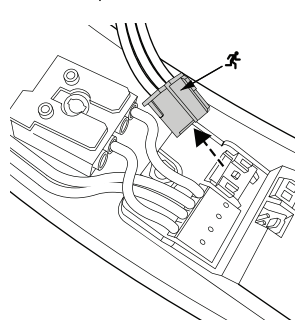

2 ⚠

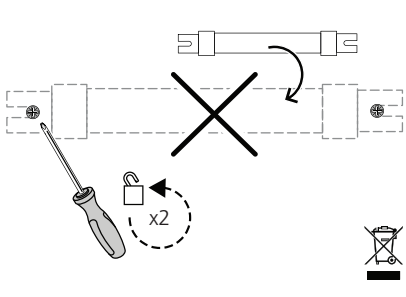

3 ⚠

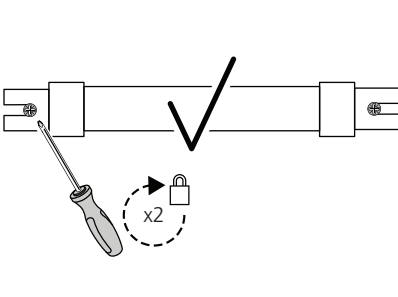

4 ⚠

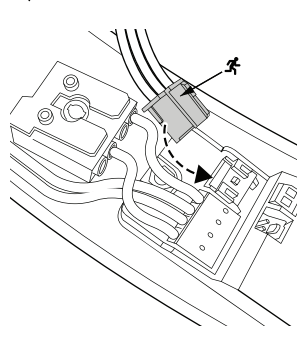

Commissioning Date: ?? / ?? / 202?

Y-type

